

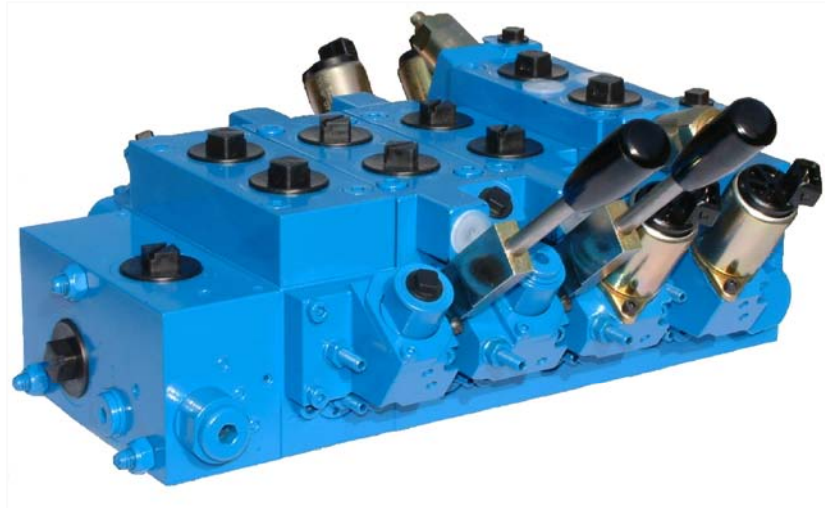

**Proportional Directional Control Valve  
Load-Sensing Pressure Compensated**

Electrical, Manual and Hydraulic operation

Series APV-16



**Features.**

- \* Modular assembly system, suitable for 'Build Program'.
- \* Max. operating pressure 420 bar.
- \* Different spooltypes up to 120 l/min. in combination with simultaneously control.
- \* Compact sandwich design, suitable for mobile applications.
- \* Several inlet plate types available for different types of pumps.
- \* Operating control in any combination (electrical, manual and hydraulic).
- \* Adjustable  $\Delta P$  for setting the maximum flow.
- \* Several user relief options as primary-, shock-, suction- and remote control functions.
- \* One full flat surface for mounting in any position.
- \* Standard seawater resistant

# TECHNICAL DATA

Max. flow :	port P1 or P2	160 l/min *
	port P1 + P2	260 l/min
	port A/B	120 l/min
	port A/B without compensator	140 l/min
Max. pressure:	port P/A/B	420 bar
	port T	35 bar
Pressure setting range		13-420 bar Manual operating 20-420 bar Electrical operating
Nominal pressure drop over 2-way compensator (A,B)		7 bar
Internal pilot pressure supply		28 bar
Pilot pressure for electrical and hydraulic control		6-22 bar
Spool stroke		5,25 mm
Spool overlap (dead band)		1,25 mm (24% of the spool stroke)
Fluid		Mineral oil according to DIN 51524/51525
Fluid temperature range		- 30 ... + 80°C
Viscosity range		10 ... 500 cSt, optimal 30cSt
Contamination level max		According to NAS 1638 Class 8 or ISO 4406: 18/16/13
Mounting position		Optional

## Connections

	BSP	SAE ORB
Port P/T	G3/4"	12
Port A/B	G3/4"	12
Port LS	G1/4"	6
Port L	G1/8"	4
Port Ya, Yb	G1/4"	6
Electrical connections	AMP Junior Power Timer	

## Electrical

Nominal voltage	12 VDC or 24 VDC
Nominal current	12 VDC = 1300 mA 24 VDC = 650 mA
Coil resistance	12 VDC = $5,3 \pm 5\% \Omega$ 24 VDC = $21,2 \pm 5\% \Omega$
Recommended dither frequency	100 Hz
Type of protection	IP 65
Duty cycle	100%
Hysteresis	3% <span style="float: right;">* Pumpflow, see note page 14</span>

Different flowtypes:  
(with compensator)

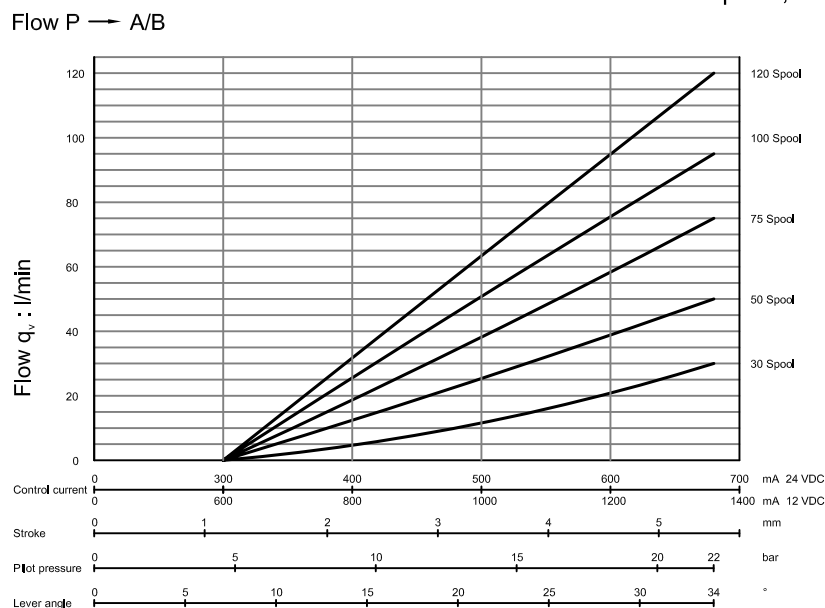

# TECHNICAL DATA

Technical data

## Technical information.

The unique modularity of the APV enables system solutions for manufacturers of mobile machines, as a wide range of functions can be integrated/changed by the customer in an easy, flexible and cost-effective way.

### Inlet Plate.

Inlet plates are available for fixed and variable displacement pumps, and constant pressure networks. Functions as:

- anti saturation;
- pump unloading;
- pressure relief;
- LS signal amplifier and combinations thereof; can be integrated into the inlet plate.

### Control Valve.

The control valve consists of spool section and connection block.

### Spool Section.

The main advantage of the APV-series is the standardization of the spool section. Different types of spools and control methods are available. Up to 12 control valves, with or without a 2-way compensator can be stacked. For perfect system stability the 2-way compensator can be equipped with a damping function. Check valve function is also available within this compensator. Stroke limitation per port and  $\Delta p$ -setting per section is standard.

### Connection Block.

A very wide range of optional functions can be delivered using several, easy to mount, low cost, connection blocks. Besides a basic connection block, optimized customization can be achieved by the following functions:

- remote controlled pressure setting/unloading per port;
- adjustable secondary pressure setting per port;
- suction valves and shock/suction valves per port;
- adjustable primary port relief per port with excellent relieving characteristic.

Any other special functions can be easily integrated into special connection blocks on request.

### End Plate.

Also the end plates for different control methods can be equipped with optional functions as:

- additional P-port;
- Z-port to enable a LS-cascade with another valve;
- feeding point for hydraulic joysticks.

### Safety.

To comply with national and international safety regulations, special safety functions can be integrated as described above.

### Serviceability.

The modular concept ( build-program) improved the servicing of the APV.

All orifices and shuttle valves are directly attainable from the outside of the valves.

### Symbols and Terminology.

Graphic symbols in accordance with ISO1219-1.

Identification of valve ports in accordance with ISO 9461.

For the purposes of this document, the definitions and terminology given in ISO 5598 and the following definitions apply:

- LS : load sensing
- Primary relief : relief function in the flow line, e.g. the 3-way compensator in the inlet plate and the shock/suction valve in the connection block.
- Secondary relief : relief function in the signal line, e.g. max. load pressure relief in the inlet plate.

Inlet plate

Control valve

End plate

Applications

Dimension

Ordering code

# TECHNICAL DATA

# Modularity

## Inlet plate

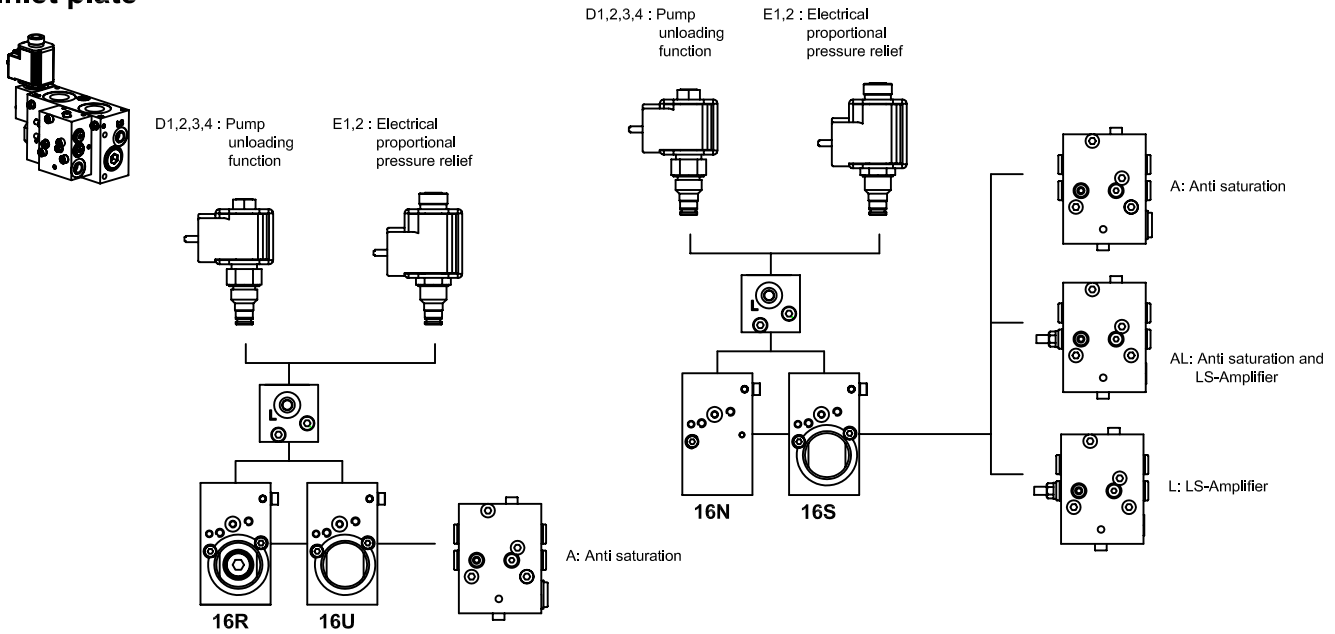

## Connection block (some possibilities)

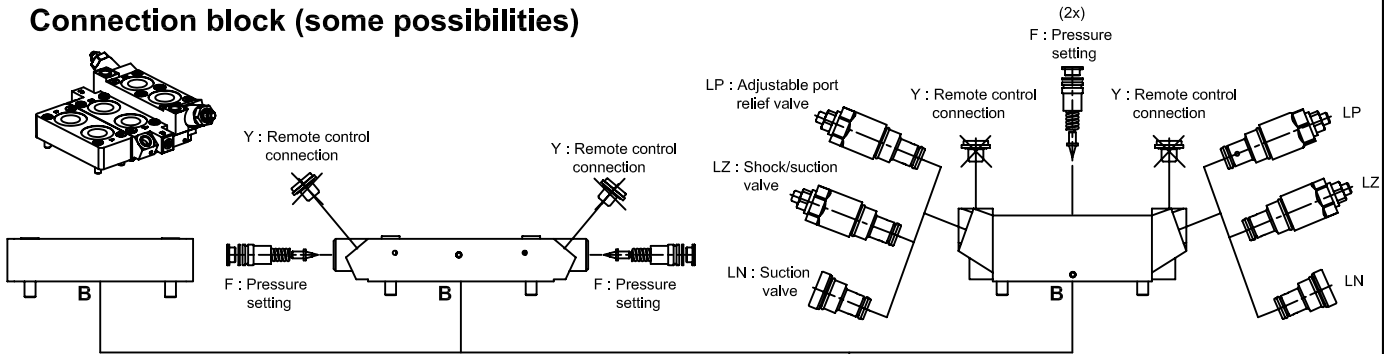

## Spool section

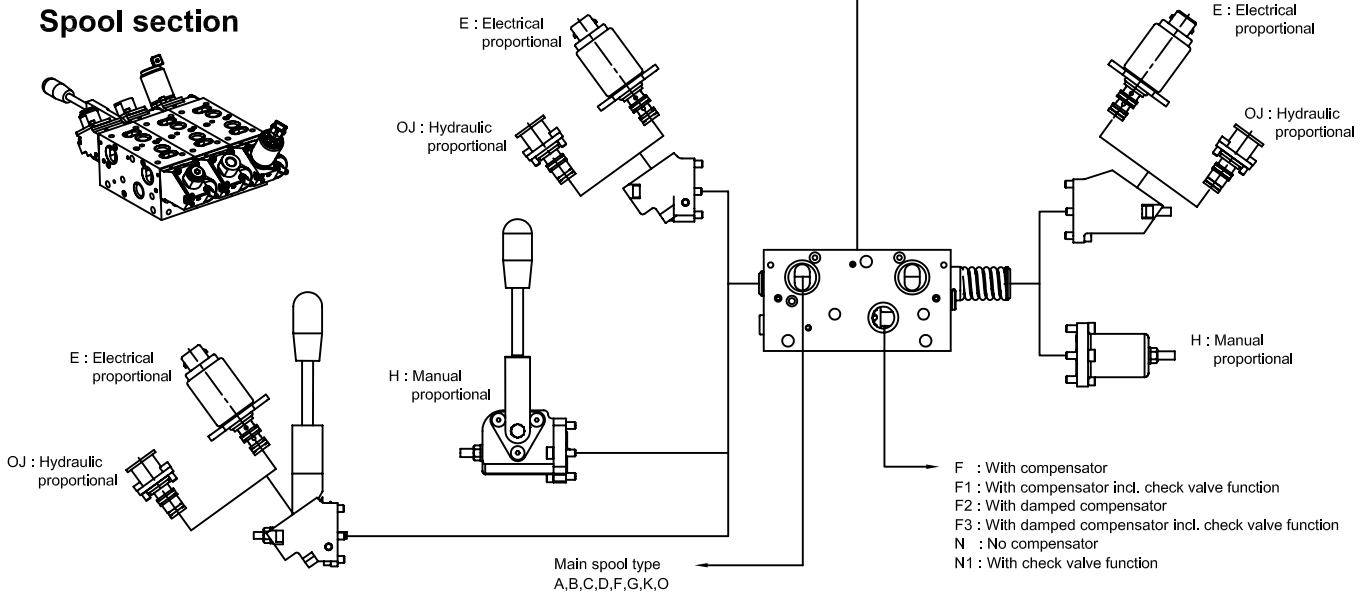

## End plate

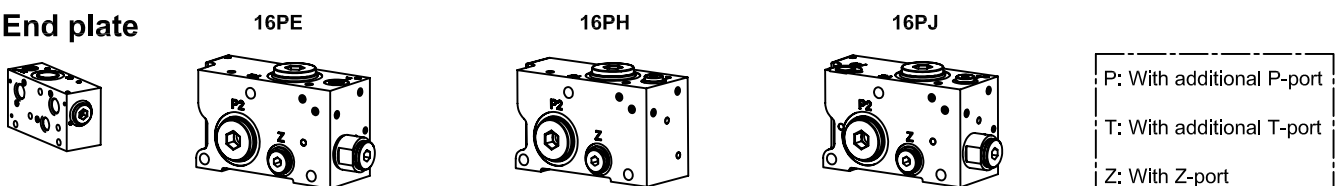

# TECHNICAL DATA

Description

Example:

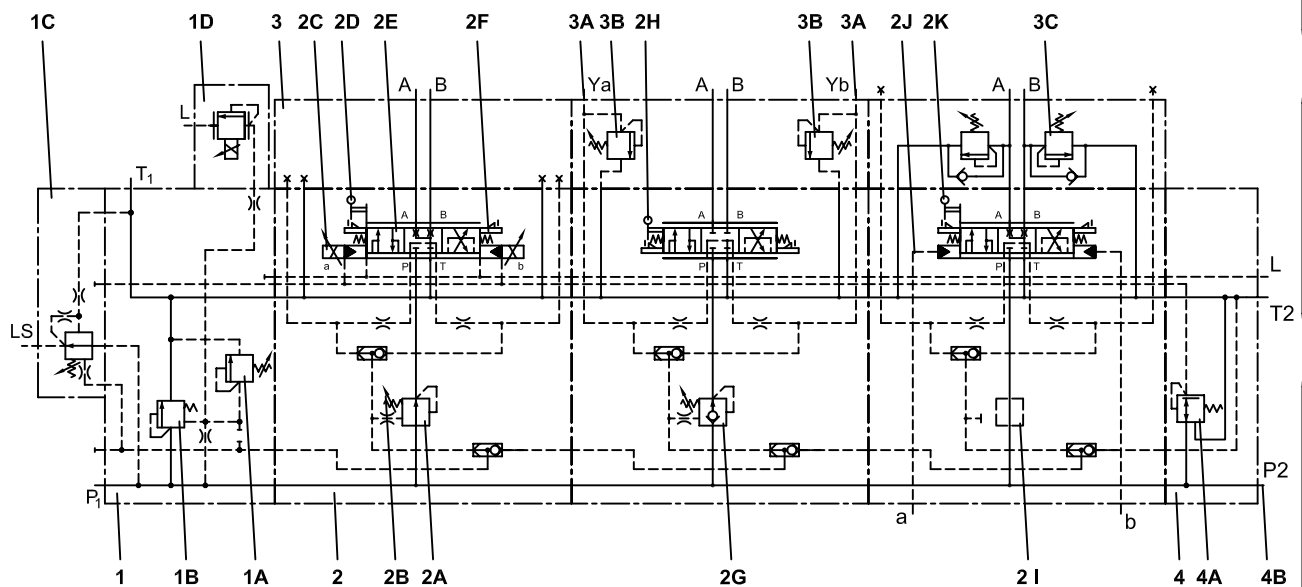

Pos. Description:

- 1 **Inlet plate**, several types available for different types of pumps
- 1A Adjustable load pressure relief, standard on all types of inlet plate
- 1B Pump relief function
- 1C LS-amplifier, for strong signal and perfect stability of the LS-pump
- 1D Electrical proportional pressure relief

- 2 **Spool section**, basic section for different main spool types and compensator variants
- 2A 2-way compensator for load-independent control and simultaneously operation
- 2B Flow adjustment by regulating the pressure drop across the main spool
- 2C Control method: Electrical proportional
- 2D Additional manual control
- 2E Main spool type
- 2F Adjustable stroke limitation for adjusting the max. flow per port
- 2G As 2A, with check valve to P-line
- 2H Control method: Manual proportional
- 2I No 2-way compensator per section
- 2J Control method: Hydraulic Proportional
- 2K Additional manual control

- 3 **Connection block**, separate block for all different types of options
- 3A Remote control connection on port A and B (optional)
- 3B Adjustable pressure setting on port A and B (optional)
- 3C Shock/Suction valves port A and B (optional)

- 4 **End plate**
- 4A Pressure reducing valve, for electrical control
- 4B Additional pump connection (optional)

Technical data

Inlet plate

Control valve

End plate

Applications

Dimension

Ordering code

# INLET PLATE

## INLET PLATE

For every pump type an inlet plate is available:

### Fixed displacement pump

The APV inlet plate version 16U, fig. 1, is designed for fixed displacement pumps.

The main relief in this section is functioning as a 3-way compensator.

If none of the control sections are in operation, the inlet plate version 16U creates about 14 bar in the pumpline. Actuating one of the control sections, the specific load pressure is added as signal to the spring chamber. Actuating more control sections at the same time, the highest load pressure will be added.

The load signal pressure is also controlled by the max. load pressure relief.

This relief can be adjusted (14 ... 420 bar).

To feed also another circuit, an inlet plate 16R is available.

(see application examples).

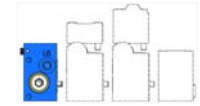
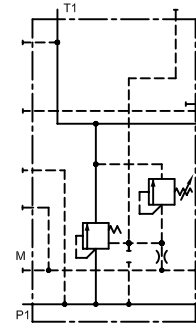

Fig.1



16U420B

### Variable displacement pump (LS-pump)

The APV inlet plate versions 16N and 16S are designed for this pump type.

The version 16N, fig. 2, has the function as inlet block for P, T and LS (load sense line). The load sense signal from the valveblock can be adjusted, up to 420 bar, with the relief valve.

Version 16S, fig. 3, has an overpressure safety function.

The relief valve can be adjusted to max. pumpline pressure and the relief spool reduces the overpressure by relieving the pumpflow to tank.

Fig.2

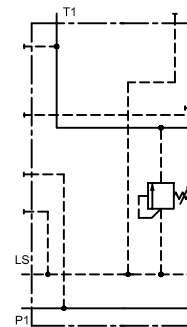

16N420B

Fig.3

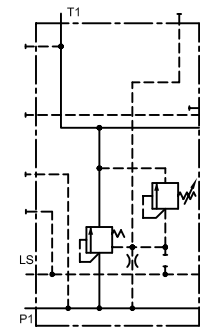

16S420B

### Pressure compensated pumps / Constant pressure networks

The APV inlet plate version 16N, fig. 2, is also designed for pressure compensated pumps and constant pressure networks.

It has the function as inletblock for P, T. The LS connection G1/4" (SAE 6) has to be blocked.

The load signal pressure is controlled by the max. load pressure relief.

The max. load pressure of the valve block can be adjusted (up to 420 bar).

Fig.1A



16U420B

Fig.2A



16N420B

Fig.3A



16S420B

Flow P → T2

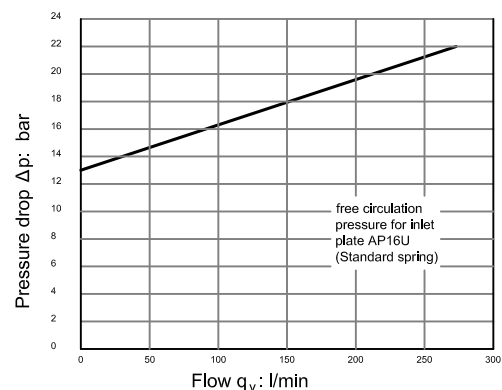

# INLET PLATE

## Additional functions for all types of pumps:

### Anti saturation function, code A, fig. 4

The anti saturation function is developed for electrical and hydraulic controlled valves. If the valve block has insufficient pumpflow, the user flow for every control section will be reduced with this function so that every control section keeps working simultaneously.

Fig.4

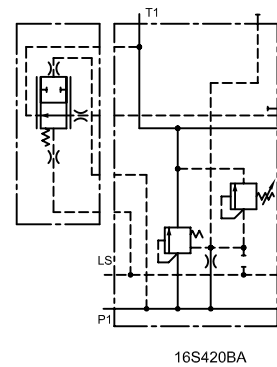

### Electrical proportional pressure relief, code E, fig. 5

For remote control of the maximum pressure of the valve block, the electrical proportional pressure relief is available in 12 VDC and 24 VDC.

Fig.5

Fig.6

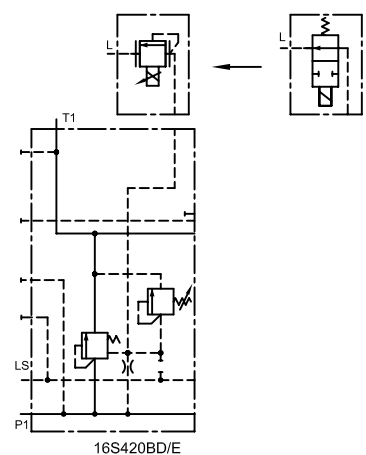

### Pump unloading function, code D, fig. 6

For emergency stop function the load pressure signal from the control sections can be unloaded directly to tank. The electrical control is available in 12 VDC and 24 VDC with 2/2-way cartridge in normal-open or normal-closed configuration. The example shows a normal-open configuration. Please note that the recirculation pressure or stand-by pressure is still on the P-line.

## Additional function for LS pumps:

### LS-Amplifier, code L, fig. 7

This option enables increasing the LS pressure signal if some LS-pumps have a continuous leak of the load-pressure signal to tank. This option can also be used for fine-tuning of the stability of the pump and the proportional control. With the adjustment screw the stand-by pressure of the LS-pump is adjustable within 4 bar.

Fig.7

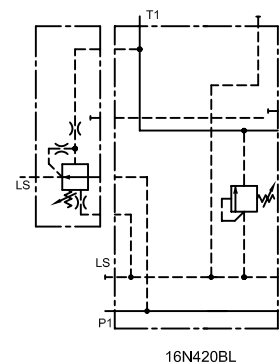

Fig.4A

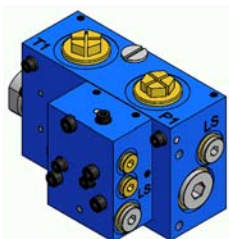
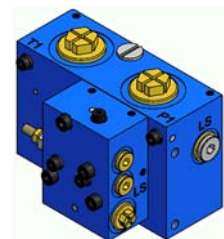

Fig.5A



Fig.7A



Technical data

Inlet plate

Control valve

End plate

Applications

Dimension

Ordering code

# CONTROL VALVE

## CONTROL VALVE.

On the basis of the build-program principles the APV-16 control valve consists of I standardized spool section and II basic or customized connection blocks and spring- and endcaps. Max. 12 control sections.

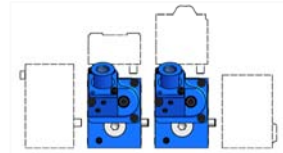
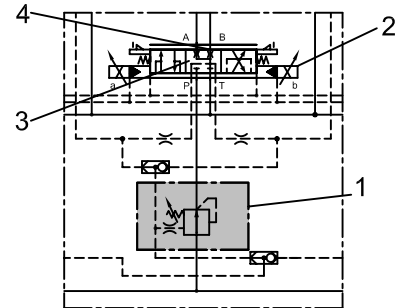

Fig.8



### I Spool section:

- 1 Compensator types;
- 2 Control method : electrical, hydraulic and manual control;
- 3 Spool types;
- 4 Flow per port.

### 1. Compensator types :

The various compensators enable load independent flow control and possibility of simultaneous operation. The max. flow can be pre-adjusted by adjusting the compensator spring. At part 1 from fig. 8 the following types can be mounted:

#### Code:

F: 2-way compensator

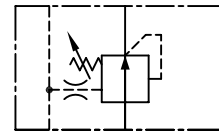

F1: 2-way compensator with load-hold check valve

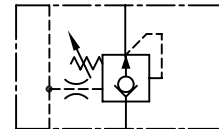

F2: 2-way compensator with damping function.

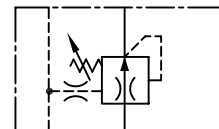

F3: 2-way compensator with load-hold check valve and damping function.

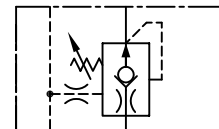

N: Without compensator.

Note: Max. flow depends on stand-by pressure setting in case of using LS-pump

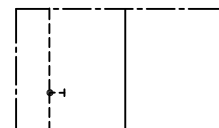

N1: Load-hold check valve.

Note: Max. flow depends on stand-by pressure setting in case of using LS-pump

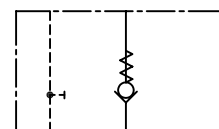



# CONTROL VALVE

## 2. Control method :



E = electrical control

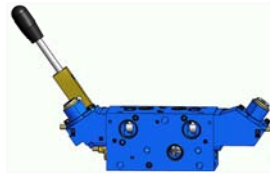

H = manual control



OJ = hydraulic control

The electrical- and hydraulic control can be configured in combination with an additional manual control. All the control methods are standard equipped with stroke limiters for separate fine-tuning the flow of A and/or B port. The cartridge cavity in the end-caps is suitable for all three control methods.

### E: electrical control:

The reducing cartridge is integrated within the proportional solenoid 24 VDC or 12 VDC. All the control sections have a pilot supply pressure and return line, which must be fed through the end plate type 16PE. The 16PE end plate is equipped with a separate "L"-connection to drain the pilot return line to tank, which creates a perfect system stability.

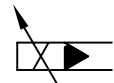

### H: manual control:

If the handle is not actuated, the spring assembly keeps the spool in neutral position (code HF). The manual control can be configured with detent or friction brake. Detent (code HR): the spool can be set in any position, the center position and both end positions are perceptible. Friction brake (code HB): the spool can be set in any position, the center position is perceptible.



### OJ: hydraulic control:

For hydraulic remote control, the endcaps have G1/4" connections.



## 3. Spool types .

The spool is available for different types of users, like single and double acting cylinders and hydraulic motors.

Code:	Symbol:	Remark	Code:	Symbol:	Remark
A		In neutral position all ports blocked	F		In neutral position all ports blocked
B		In neutral position port A throttled flow to T (approx.20% of nominal flow)	G		In neutral position port A+B throttled flow to T (approx.20% of nominal flow)
C		In neutral position port A+B throttled flow to T (approx.20% of nominal flow)	K		In neutral position all ports blocked, A port blended *
D		In neutral position port B throttled flow to T (approx.20% of nominal flow)	O		In neutral position all ports blocked, B port blended *

\* Port is blended with stop in the connection block

## 4. Flow per port .

Each user port can be set at different flow. The flow with compensator is up to 120 l/min and without compensator the flow is up to 140 l/min.

By adjusting the compensator spring ( $\Delta p$  adjustment) the flow of A and B port can be pre-adjusted. By using the stroke limiters the flow of A and/or B port can be adjusted separately.

# CONTROL VALVE

## II Connection block.

The main flexibility of APV series is realized by various connection blocks with a very wide range of optional functions. The connection block is the only part to be customized in order to meet special requirements.

The available connection blocks are:

- 1 - basic version only with A and B ports
- 2 - version with secondary safety functions
- 3 - version with primary safety functions
- 4 - version with primary and secondary safety functions
- 5 - customized versions

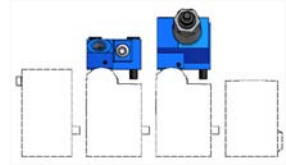

The code of the connection block has to start with the type of the thread of the connection port (3/4" BSP or SAE 12). The other threads are on request.

### 1. Basic version:

The basic version is a connection block with only A and B ports.

code:

- B: The connection A and B port is 3/4" BSP.
- S: The connection A and B port is SAE 12

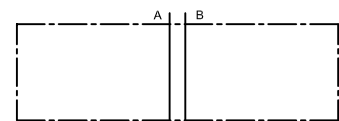

xxxxx-B  
xxxxx-S

### 2. Version with secondary safety functions:

The version with secondary safety functions is a connection block with possibility of two secondary safety functions. Secondary safety functions are active at the load pressure signal lines, so overpressure (reached maximum load pressure) causes a small amount of oil from the load sense signal vented to tank at maximum pressure. This in contrast with the primary relief valves, whereby the full userflow has to be vented to tank at maximum pressure. Secondary reliefs are only in function if the control valve is actuated.

Code:

- F: Adjustable pressure setting on port A and B:  
Each user port can be set with a separate maximum load pressure relief (LS-relief).  
Factory pressure setting (first A-port then B-port) has to be mentioned in the order code.  
Adjustable pressure setting only on one port, state "-" for the other port.  
Example: A-port = 380 bar and B-port = 320 bar: "F= 380/320 bar"  
or only A-port = 380 bar: "F= 380/- bar"

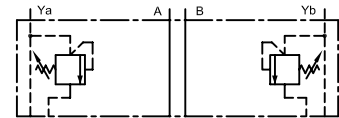

xxxxx-BFY  
xxxxx-SFY

- Y: Remote control connection on port A and B:  
The load pressure signal of each userport can be connected to system safety relief devices, through Ya and Yb(1/4"BSP or SAE 6).  
Example: cylinder stroke limiting or overload control function in combination with a 2/2-way valve to tank.

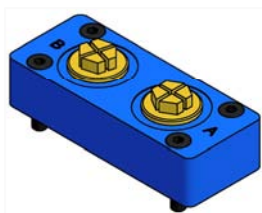

1.

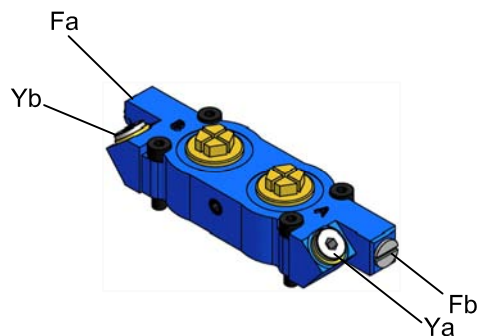

2.

# CONTROL VALVE

## 3. Version with primary safety functions:

The version with primary safety functions is a connection block with possibility of two primary safety functions. Primary safety functions are active at the user port, even if the control section is not operated. Primary safety functions are available in 2 different types. These types can be used in the same cartridge cavity. A-port as well B-port can be configured as a specific primary safety function.

### Code:

**CN:** Suction valves port A and B

The suction valve per userport prevents cavitation in the user line.

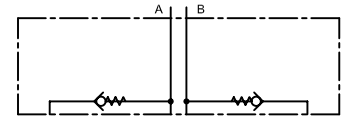

xxxxx-BCN  
xxxxx-SCN

**CZ:** Shock/Suction valves in port A and B

Combined shock/suction valves prevents the user line to relief temporary pressure peaks and prevent cavitation.

Factory pressure setting (first A-port then B-port) has to be mentioned on configuration code. Adjustable pressure setting only on one port, state "-" for the other port.

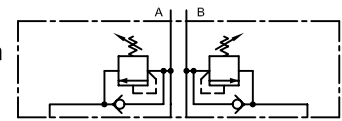

xxxxx-BCZ  
xxxxx-SCZ

Example: A-port = 345 bar and B-port = 320 bar: "CZ= 345/320 bar"  
or for only A-port = 345 bar: "CZ=345/- bar"

### Note:

- Max. operating pressure for CN and CZ is 345 bar

CN or CZ



CN or CZ

3.

## 4. Version with primary and secondary safety functions:

The version with primary and secondary safety functions is a connection block available in 2 different types.

**4A.** Connection block exist from 2 primary and 2 secondary safety function with a max. operating pressure off 345 bar.

Primary safety functions are active at the user port, even if the control section is not operated.

Primary safety functions are available in 2 different types. These types can be used in the same cartridge cavity. A-port as well B-port can be configured as a specific primary safety function.

### Code:

**CN:** Suction valves port A and B

The suction valve per userport prevents cavitation in the user line.

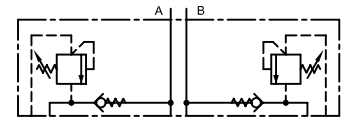

xxxxx-BFCN  
xxxxx-SFCN

**CZ:** Shock/Suction valves in port A and B

Combined shock/suction valves prevents the user line to relief temporary pressure peaks and prevent cavitation.

Factory pressure setting (first A-port then B-port) has to be mentioned on configuration code. Adjustable pressure setting only on one port, state "-" for the other port.

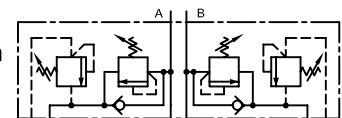

xxxxx-BFCZ  
xxxxx-SFCZ

Example: A-port = 345 bar and B-port = 320 bar: "CZ= 345/320 bar"  
or for only A-port = 345 bar: "CZ=345/- bar"

### Note:

- Max. operating pressure for CN and CZ is 345 bar

Technical data

Inlet plate

Control valve

End plate

Applications

Dimension

Ordering code

# CONTROL VALVE

**4B.** Connection block exist from 3 primary and 2 secondary safety function with a max. operating pressure off 420 bar. Primary safety functions are active at the user port, even if the control section is not operated. Primary safety functions are available in 3 different types. These types can be used in the same cartridge cavity. A-port as well B-port can be configured as a specific primary safety function.

**Code:**

**LN:** Suction valves port A and B

The suction valve per userport prevents cavitation in the user line.

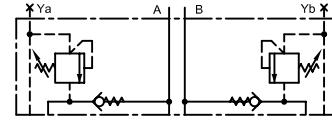

xxxxx-BFLNY  
xxxxx-SFLNY

**LP:** Adjustable port relief on port A and B

Adjustable primary port relief valve prevents the user line against overpressure during operation and also in neutral position. The flow over the relief is maximum 120 l/min.

For the range up to 420 bar the adjustable port relief has to be configured for the following steps:

LPB: range 35 - 140 bar

LPV: range 70 - 280 bar

LPG: range 140 - 420 bar

Factory pressure setting (first A-port then B-port) has to be mentioned on configuration code.

Adjustable pressure setting only on one port, state "-" for the other port.

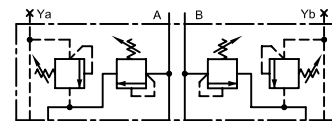

xxxxx-BFLPY  
xxxxx-SFLPY

Example: A-port = 320 bar and B-port = 280 bar give orderingcode "LPG=320/280"

A-port = 320 bar and B-port = no port relief give orderingcode "LPG=320/-"

**LZ:** Shock/Suction valves in port A and B

Combined shock/suction valves prevents the user line to relief temporary pressure peaks and prevent cavitation.

Factory pressure setting (first A-port then B-port) has to be mentioned on configuration code. Adjustable pressure setting only on one port, state "-" for the other port.

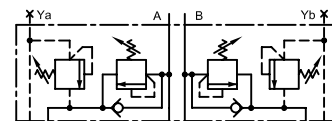

xxxxx-BFLZY  
xxxxx-SFLZY

Example: A-port = 380 bar and B-port = 320 bar: "LZ= 380/320 bar"

or for only A-port = 380 bar: "LZ=380/- bar"

**Note:**

- If A-port needs LZ-function 280 bar and B-port needs LP-function 280 bar, please note at the connection plate configuration: "LZ=280/-" and "LP= -/280".
- Additional, options "F" and/or "Y" can be configured.

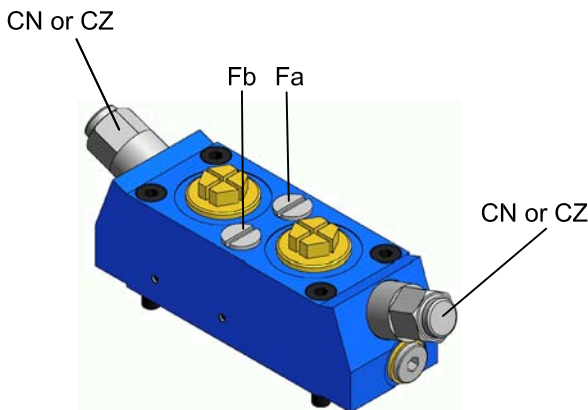

4A.

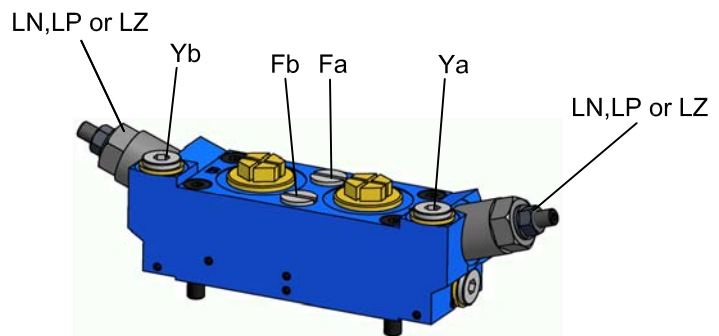

4B.

# CONTROL VALVE

## 5. Customized version:



Connection block with integrated counterbalance valve, LS-reliefs and electrically controlled 2/2-way valve.



Connection block with integrated LS-reliefs and counterbalance valves in the user ports A and B.

The unique modularity of the APV enables system solutions for manufacturers of mobile machines, as a wide range of functions can be integrated/changed by the customer in an easy, flexible and cost-effective way.

Some examples are shown below.

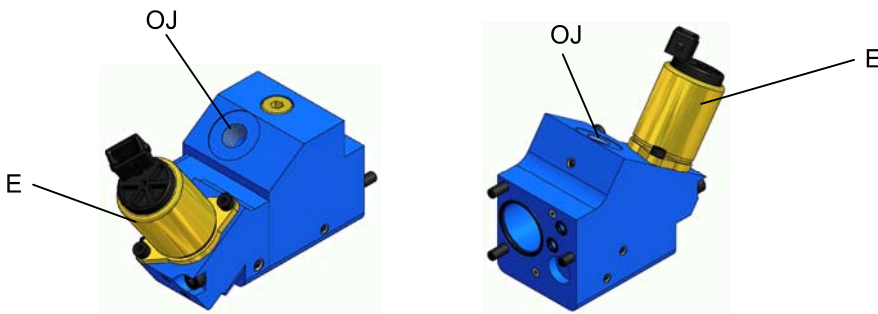

Spring and endcap with double control method electrical and hydraulic proportional.

Technical data

Inlet plate

Control valve

End plate

Applications

Dimension

Ordering code

# END PLATE

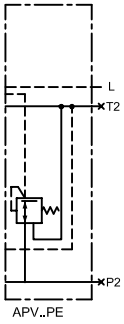

Code PE: For control method E

End plate with built-in pressure reducing valve for internal pilot pressure supply of 28 bar to the electrical pilot valves of each electrical proportional control valve.

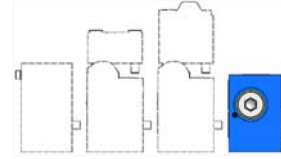

Code PH: For control method H or O

End plate for manual or hydraulic operated valves.

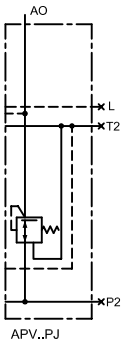

Code PJ: For control method E or O

End plate with built-in pressure reducing valve for external pilot pressure supply of 28 bar to the hydraulic joysticks.

16PE/PZ

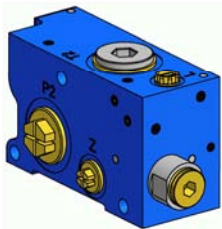

16PH/P

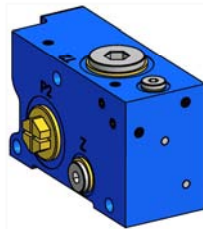

16PJ/P



# END PLATE

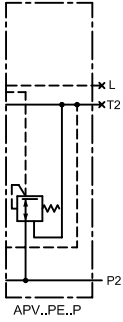

## Code P: With additional P-port

Additional P-port to connect an extra P-line in systems with high pump flow.

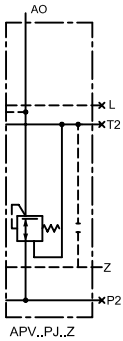

## Code Z: With Z-port

Z-port to connect the LS-signal of a second valve to the LS-cascade of the first valve, to be able to use the compensator of the first valve.

**Note:** In systems with a pumpflow > 160l/min use endplate with P<sub>2</sub> port (Ordering code 16P...P).  
For reduction of the return pressure the use of the second tank connection T<sub>2</sub> on the end plate is possible (ordering code 16P...T).

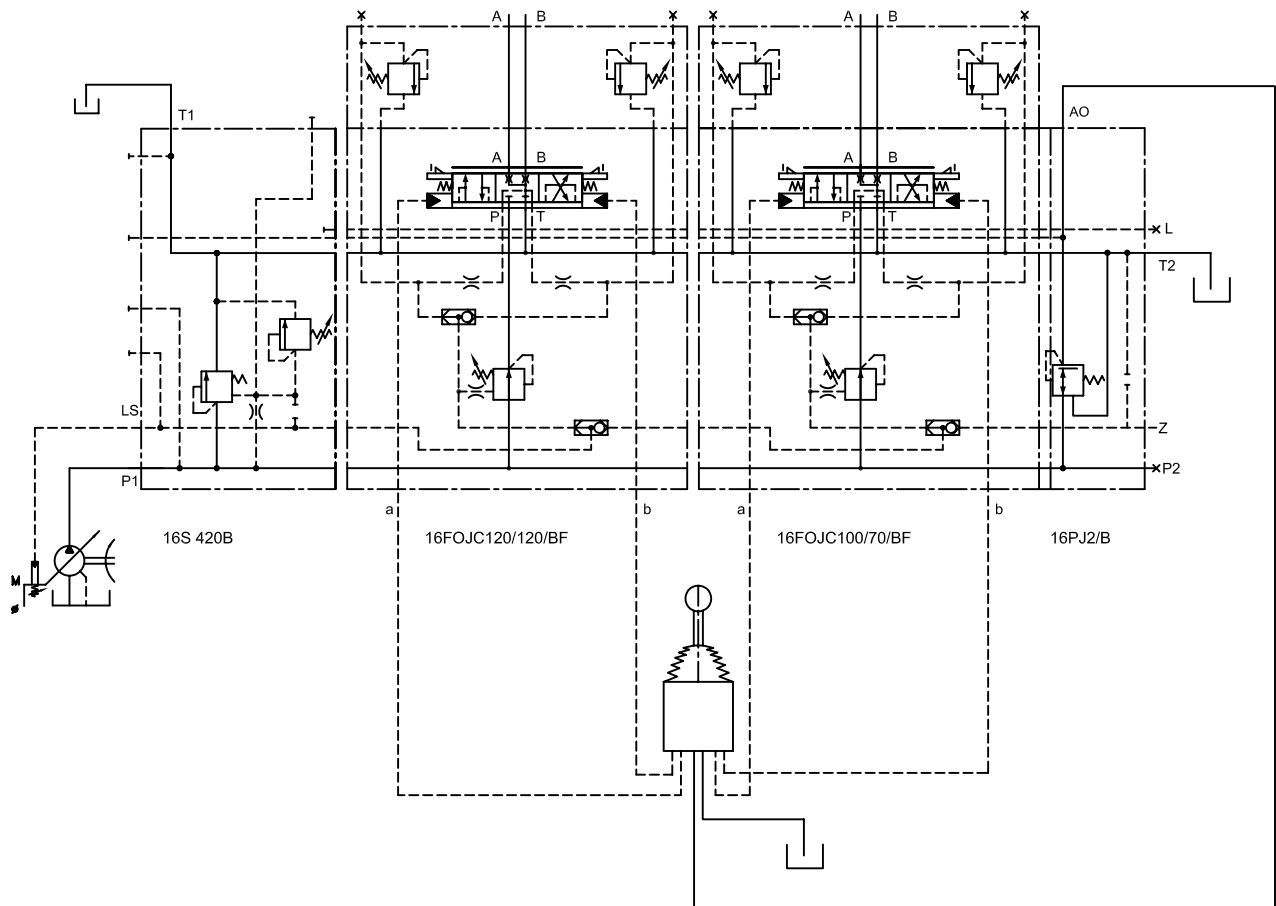

Technical data

Inlet plate

Control valve

End plate

Applications

Dimension

Ordering code

### Example inlet plate code U.

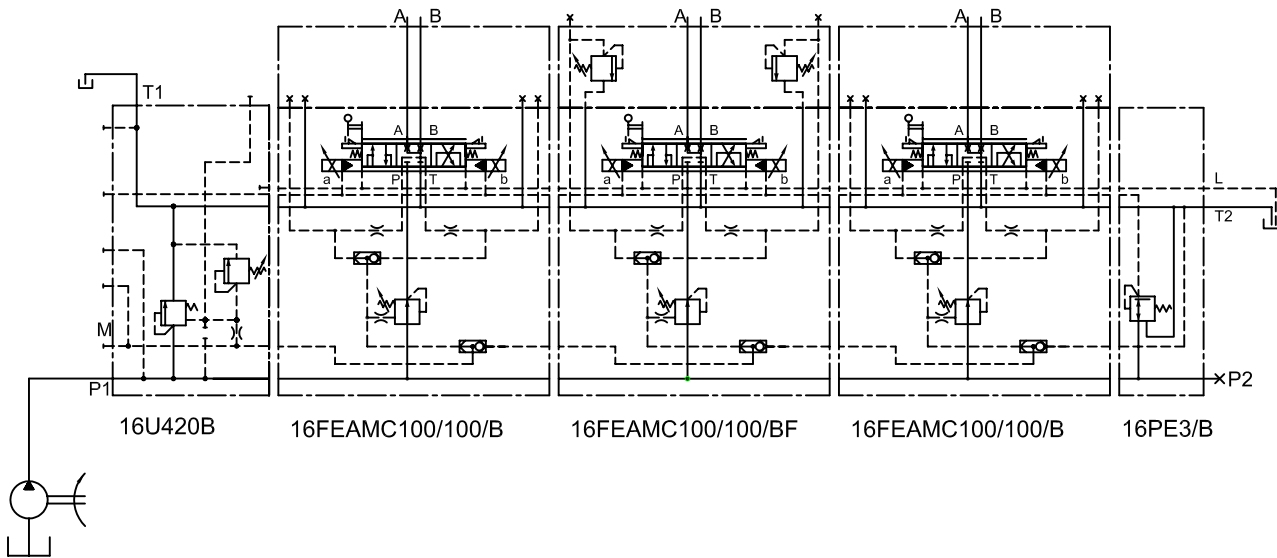

#### Code U:

##### **Inlet plate for fixed displacement pump: 16U420B**

If none of the control sections are in operation, the integrated 3-way compensator of the inlet plate 16U recirculates the flow to tank.

Actuating one of the control sections, the specific load pressure is added as signal to the spring chamber. Actuating more control sections at the same time, the highest load pressure will be added (see shuttle valve cascade system). The maximum load signal pressure is controlled by the max. load pressure relief.

If one or more of the users have to be set on a lower max. pressure, the control section can be configured with pressure reliefs per port (see for example the second section).

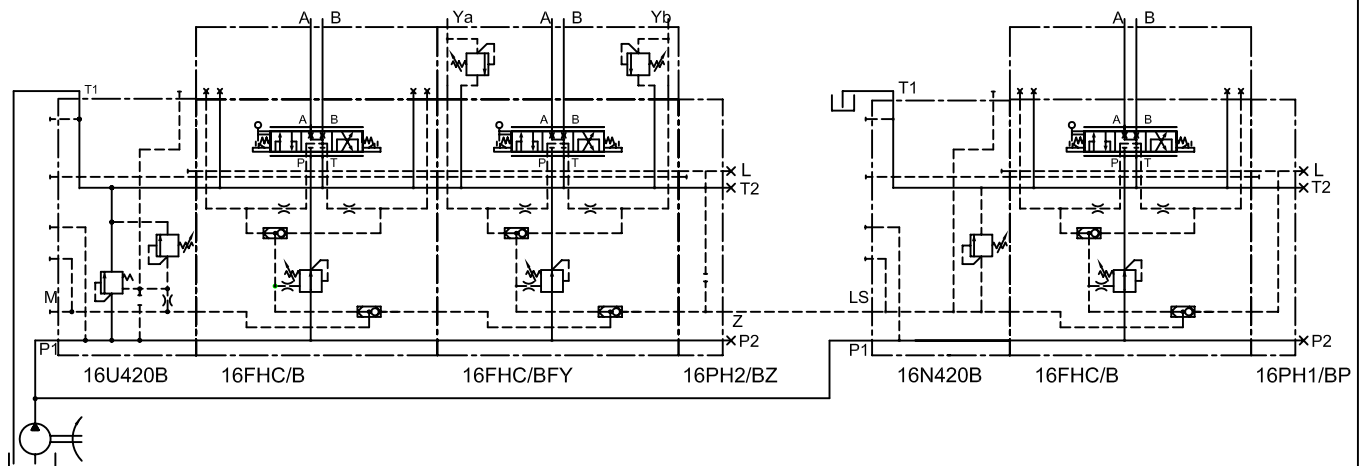

##### **Parallel circuit with fixed displacement pump: 16U and 16N**

When two valve blocks should be mounted on different places in a system one valve block can be configured with a 16N inlet plate. The valve block with the 16U is regulating the pump flow and the end plate 16P-Z has to be connected to the LS port of the second valve block with a 16N inlet plate. The max. load pressure relief of the 16N inlet plate has to be adjusted equally or lower as the max. load pressure relief at the main inlet plate 16U.



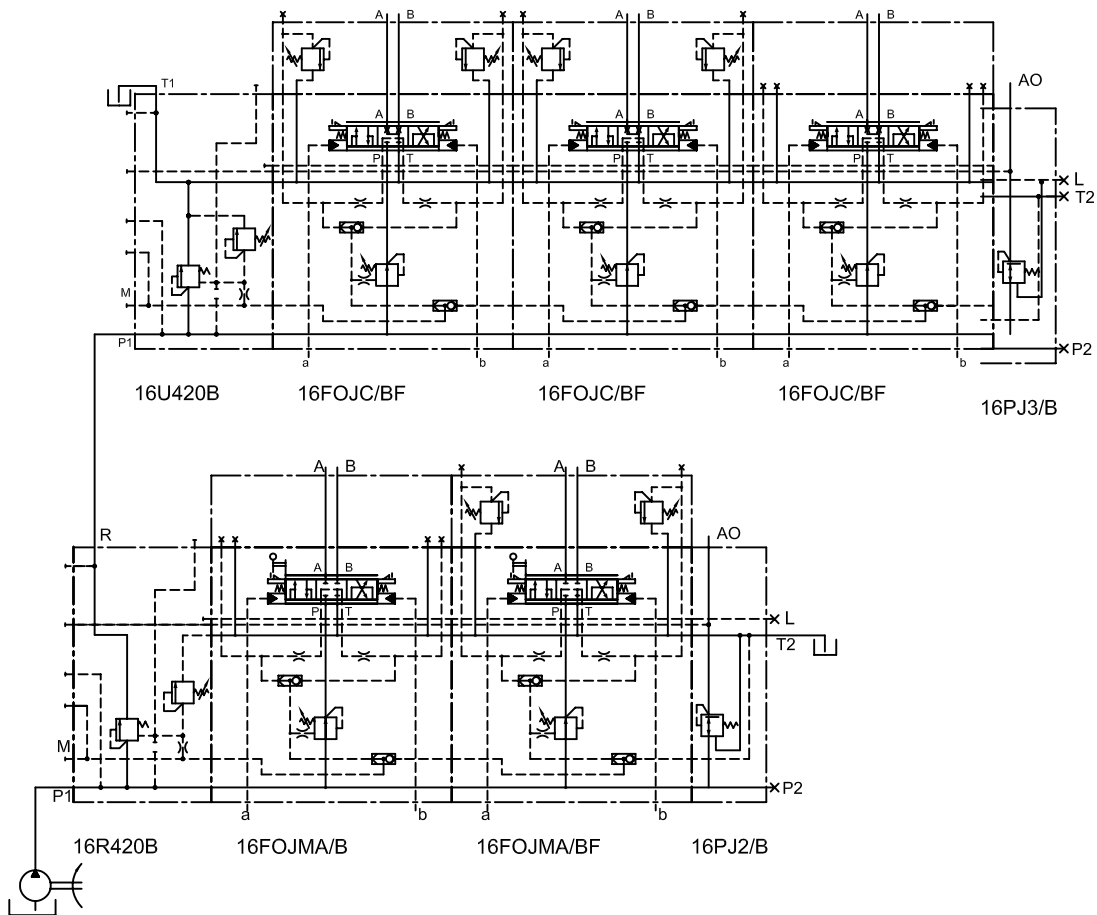

### Series circuit with fixed displacement pump: 16U and 16R

For the same condition as the parallel circuit a series circuit can be used. The advantage of a series circuit is that there is not a longer LS signal line that shall give a lower signal under colder conditions.

In the 16R inlet plate the tank circuit is disconnected from the control sections and there is an additional possibility of directing the pump flow from P to R in order to feed another circuit. Please note that with this type of valve block the T2 connection in the end plate has to be connected with tank.

### Example inlet plate code N.

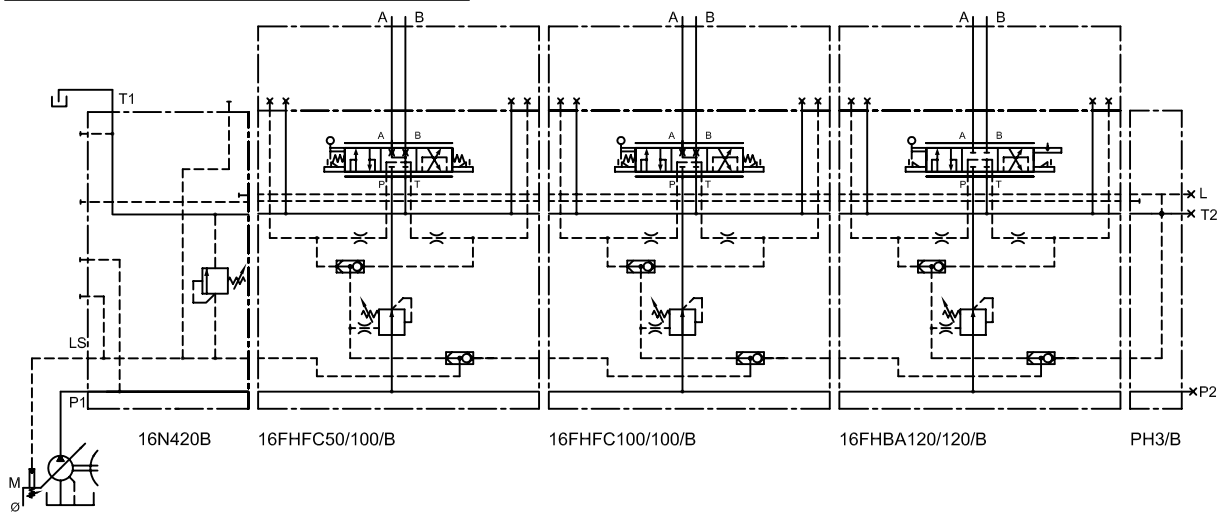

### Code N:

#### Inlet plate for LS-pumps: 16N240B

The version 16N is the inlet plate for the P, T and LS connection.

The adjustable max. pressure relief for the load signal is standard integrated.

### Example inlet plate code S.

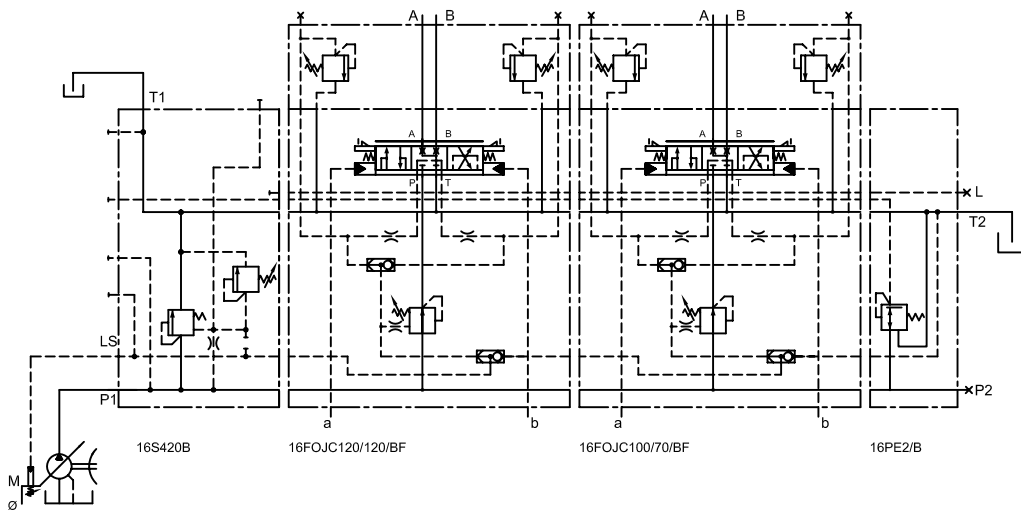

### Code S:

#### Inlet plate for LS-pump: 16S420B

The version 16S has primary overpressure safety function.

The relief valve can be adjusted to max. pumpline pressure and the relief spool reduces the overpressure by relieving the pump flow to tank.

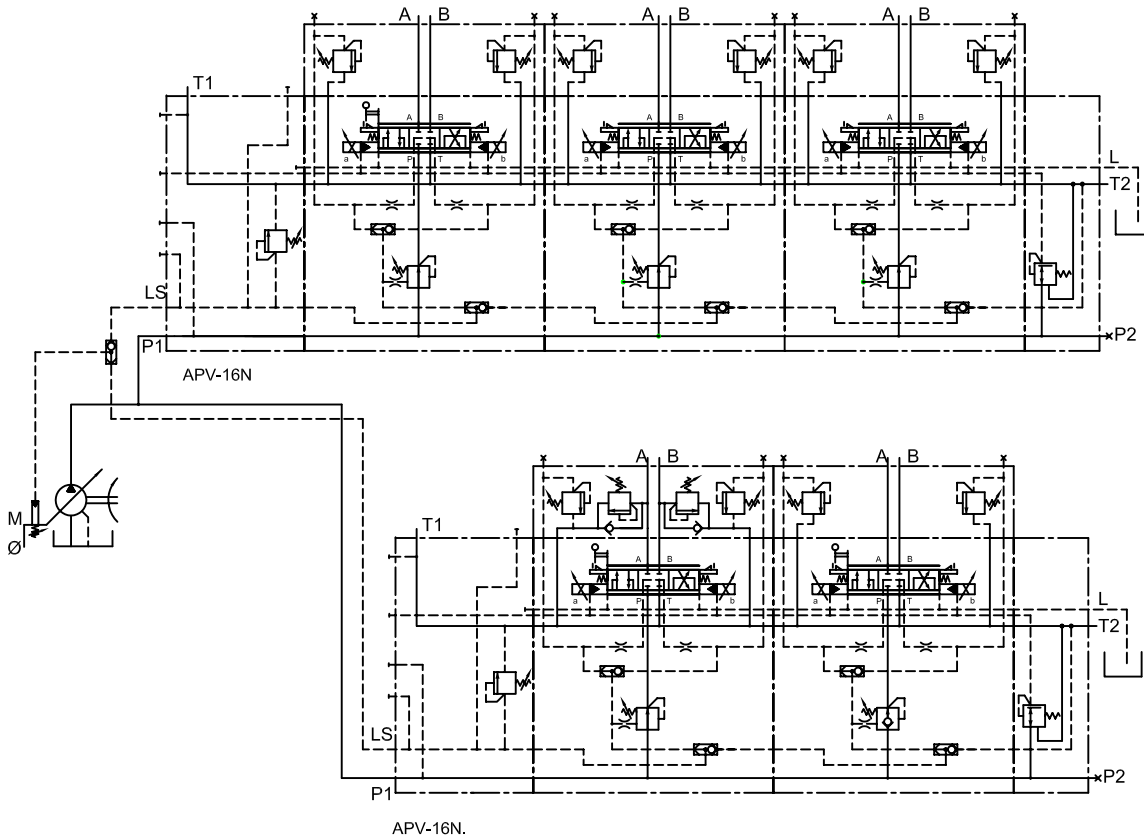

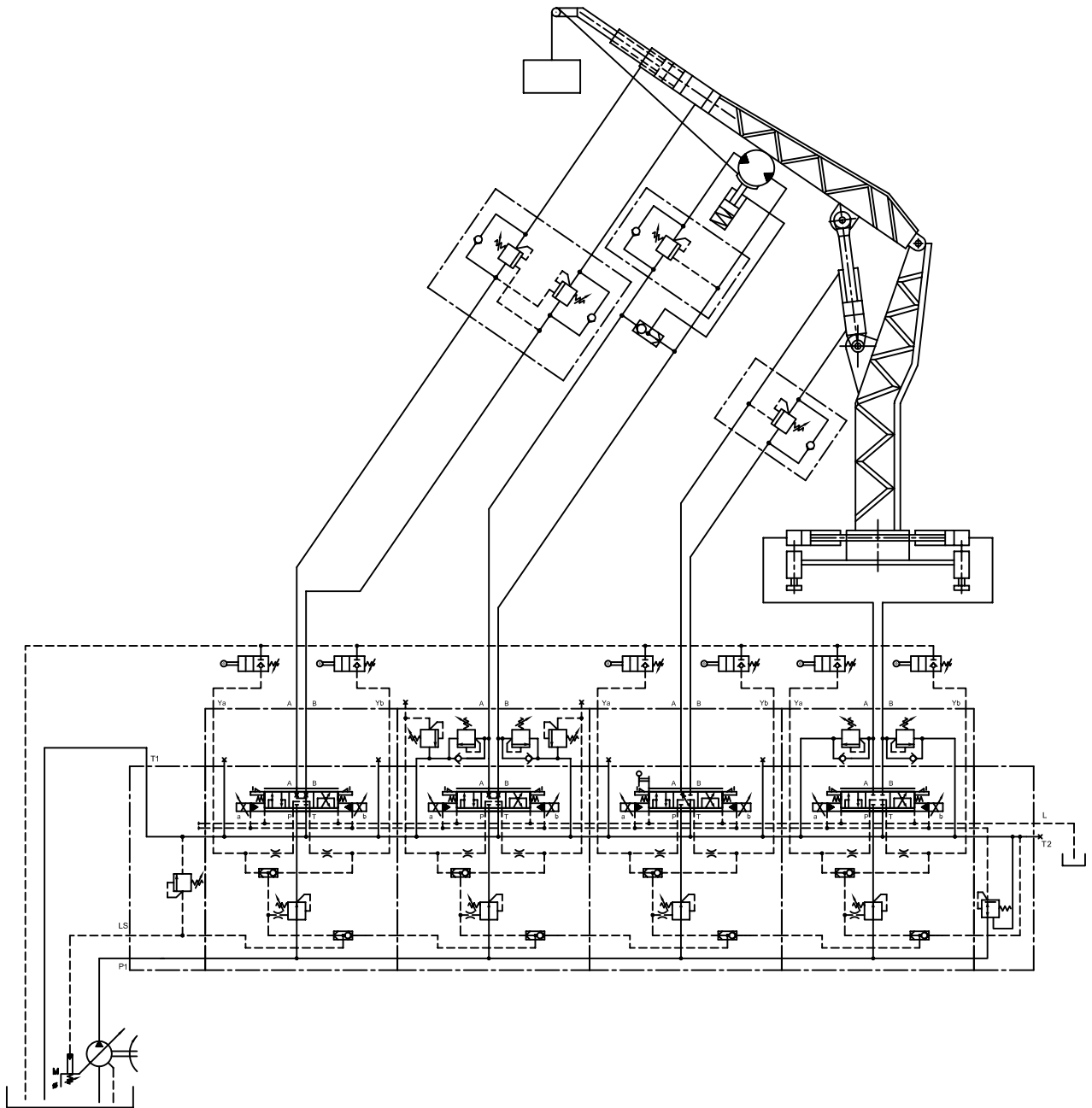

Technical data

Inlet plate

Control valve

End plate

Applications

Dimension

Ordering code

# DIMENSIONS

## Connection ports

	BSP	SAE ORB
P,T1,T2	: 3/4"	12
A,B	: 3/4"	12
LS	: 1/4"	6
L	: 1/8"	4
Ya,Yb	: 1/4"	6
A0	: 1/4"	6
Z	: 1/4"	6

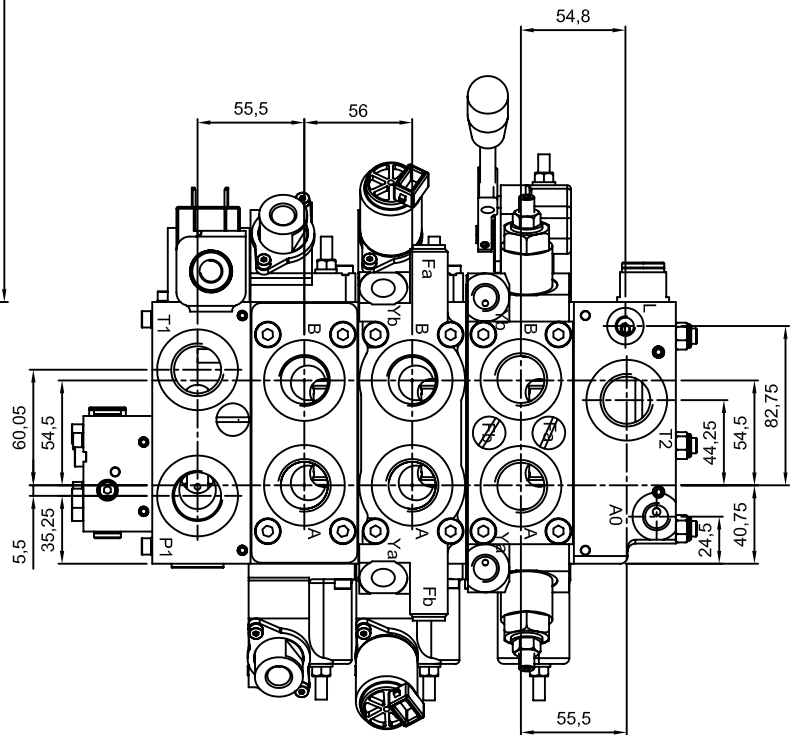
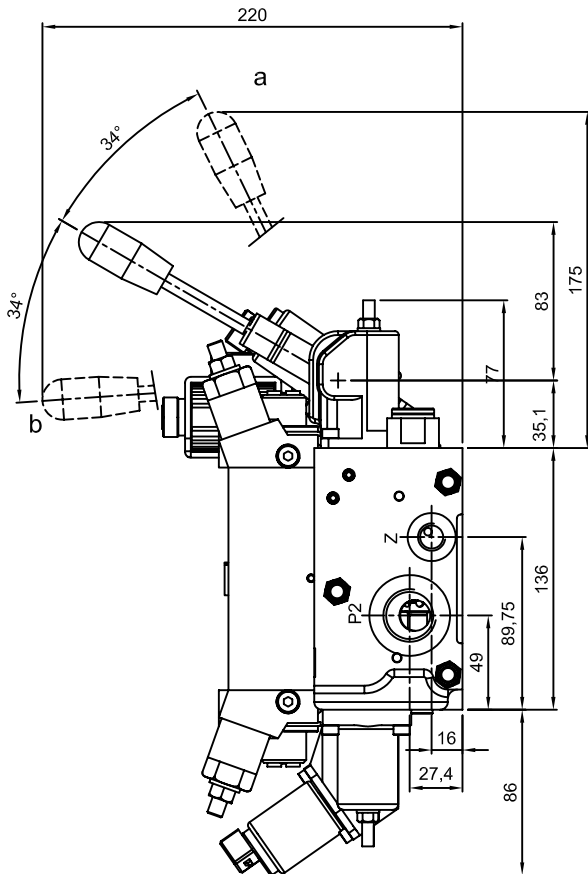
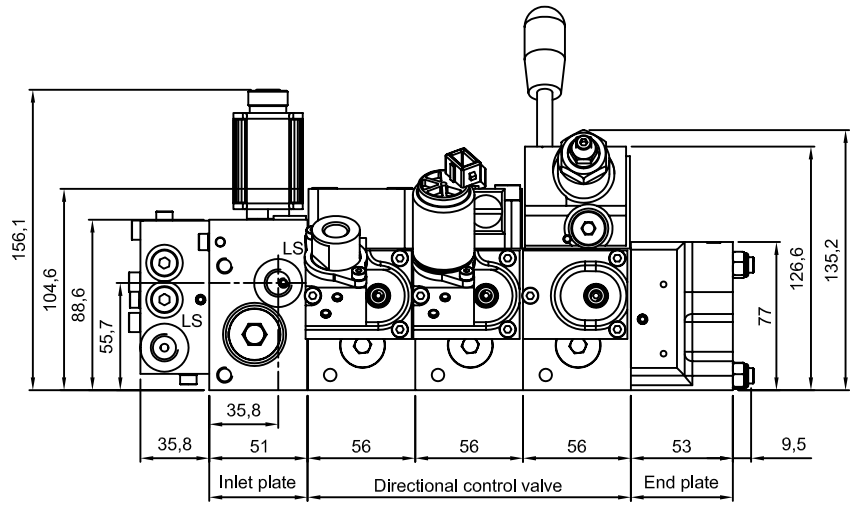

Weight:	N
Inlet plate	
16N	35
16U/S/R	36,5
Opt. D/E	7,5
Opt. A/L	12
Spool section	
16FE*	45
16FE*M	47
16FH	46
16FOJ	43
16FOJM	46

Weight:	N
Connection block	
B	14,4
BFY	16,5
BFLZY	26
End plate	
16PE	32,5
16PH	32,5
16PJ	32,5

# DIMENSIONS

Mounting holes M8 x 12

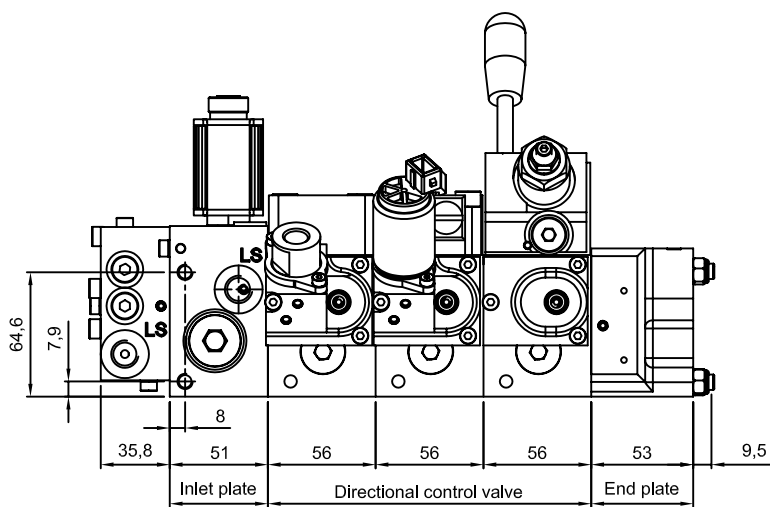
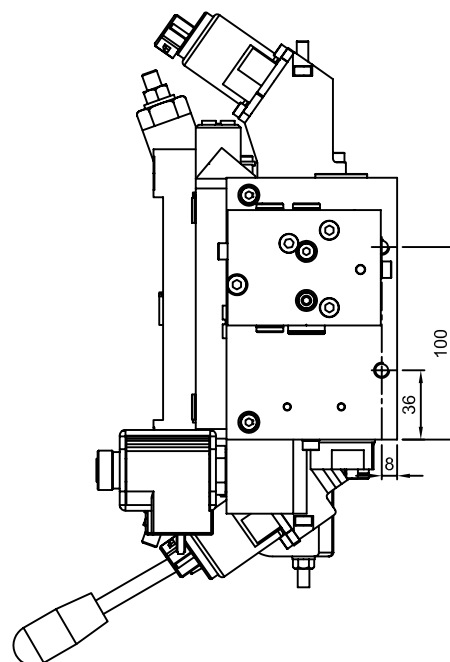
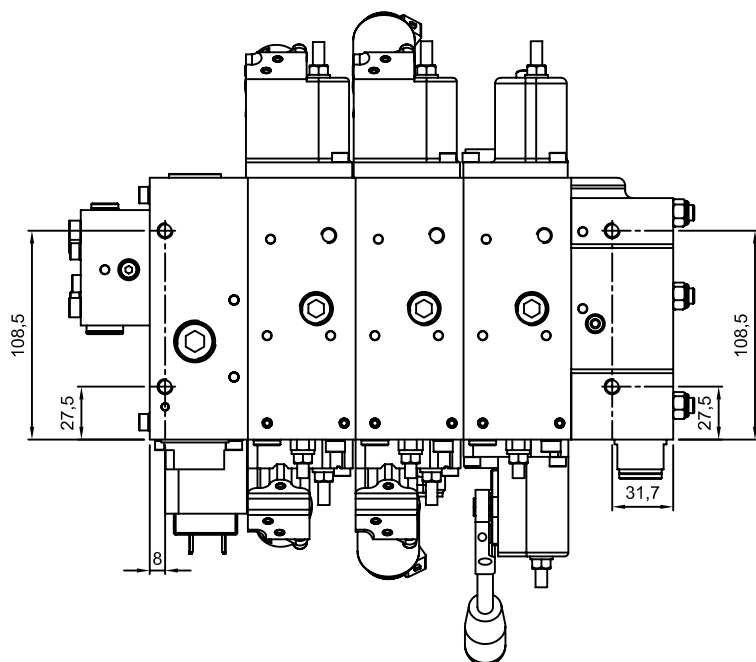

Weight assembly kit:	N
with 1 control valve	1,59
with 2 control valve	2,25
with 3 control valve	2,91
with 4 control valve	3,57
with 5 control valve	4,23
with 6 control valve	4,89
with 7 control valve	5,55
with 8 control valve	6,21
with 9 control valve	6,87
with 10 control valve	7,53
with 11 control valve	8,19
with 12 control valve	8,85

Technical data

Inlet plate

Control valve

End plate

Applications

Dimension

Ordering code



**Perth Office**

Ph: +618 9358 2300 Fax: +618 9358 2322

**Sydney Office**

Ph: +612 9675 4900 Fax: +612 9675 4985

**Brisbane Office**

Ph: +617 3246 5201 Fax: +617 3246 5241

**Email**

[info@k-1fluidpower.com](mailto:info@k-1fluidpower.com)

**Web**

[www.k-1fluidpower.com](http://www.k-1fluidpower.com)